

# SDM630 V2 100A Series

Three Phase Multifunction Din Rail Energy Meter



## DIN RAIL SMART METER FOR SINGLE AND THREE PHASE ELECTRICAL SYSTEMS

User Manual V1.3

### Warnings

Important Safety Information is contained in the Maintenance section. Familiarize yourself with this information before attempting installation or other procedures. Symbols used in this document:

Risk of Danger: These instructions contain important safety information. Read them before starting installation or servicing of the equipment.

Caution: Risk of Electric Shock

## 1.Introduction

This document provides operating, maintenance and installation instructions. These units measure and display the characteristics of single phase two wire (1p2w), three phase three wire (3p3w) and three phase four wire (3p4w) networks. The measuring parameters include voltage (V), frequency (Hz), current (A), power (kW/kVA/kVAh), import, export and total Energy (kWh/kVAh). The units can also measure maximum demand current and power, this is measured over preset periods of up to 60 minutes.

These units are Max. 100A direct connected and do not need to connect with external current transformers (CT). Built-in pulse, RS485/Mbus outputs. Configuration is password protected.

### 1.1 Unit Characteristics

The SDM630 100A V2 series meters have 7 models: SDM630-Pulse V2, SDM630-MT V2, SDM630-Mbus V2, SDM630-Modbus V2, SDM630-Standard V2, SDM630-2T V2, SDM630-Mbus-2T.

Model	Measurement	Communication	Tariff
SDM630-Pulse V2	kWh/kArh, kW/kVAh, kVA, P, F, PF, dmd, V, A, THD, etc.	NO	NO
SDM630-Standard V2	kWh/kArh	RS485 Modbus	NO
SDM630-Modbus V2	kWh/kArh, kW/kVAh, kVA, P, F, PF, dmd, V, A, THD, etc.	RS485 Modbus	NO
SDM630-Mbus V2	kWh/kArh, kW/kVAh, kVA, P, F, PF, dmd, V, A, THD, etc.	Mbus EN13757-3	NO
SDM630-MT V2	kWh/kArh, kW/kVAh, kVA, P, F, PF, dmd, V, A, THD, etc.	RS485 Modbus	4 Tariffs (RTC)
SDM630-2T V2	kWh/kArh, kW/kVAh, kVA, P, F, PF, dmd, V, A, THD, etc.	RS485 Modbus	2 Tariffs (dual source)
SDM630-Mbus-2T	kWh/kArh, kW/kVAh, kVA, P, F, PF, dmd, V, A, THD, etc.	Mbus EN13757-3	2 Tariffs (dual source)

### 1.2 RS485 Serial-Modbus RTU

\*Not for SDM630-Pulse V2, SDM630Mbus V2 and SDM630Mbus-2T

RS485 serial port with Modbus RTU protocol to provide a means of remotely monitoring and controlling the unit. Set-up screens are provided for setting up the RS485 port. Refers to section 4.2

### 1.3 Mbus

\*For SDM630-Mbus V2 and SDM630Mbus-2T only

This uses a Mbus port with EN13757-3 protocol to provide a means of remotely monitoring and controlling the unit. Set-up screens are provided for setting up the Mbus port. Refers to section 4.2

\*If the Modbus / Mbus protocol document is required, please contact us for it.

### 1.4 Pulse Output

Two pulse outputs that pulse measured active and reactive energy. The constant of pulse output 2 for active energy is 400imp/kWh (non-unconfigurable), its width is fixed at 100ms.

The default constant of pulse output 1 is 400imp/kWh, default pulse width is 100ms. Both pulse constant and pulse width are configurable through set-up menu or communication. Refers to section 4.3

## 2.Start Up Screens

The first screen lights up all display segments and can be used as a display check.

Software version information (This information is for reference only, in kind prevail.)

The interface performs a self-test and indicates the result if the test passes.

\*After a short delay, the screen will display active energy interface as follows:

Total active energy in kWh.

## 3.Measurements

The buttons operate as follows:

Selects the Voltage and Current display screens. In Set-up Mode, this is the "Left" or "Back" button.

Select the Frequency and Power factor display screens. In Set-up Mode, this is the "Up" button.

Select the Power display screens. In Set-up Mode, this is the "Down" button.

Select the Energy display screens. In Set-up mode, this is the "Enter" or "Right" button.

### 3.1 Voltage and Current

\*Not for SDM630-Standard V2.

Each successive press of the button selects a new parameter:

Phase to neutral voltages.

Current on each phase.

Phase to neutral voltage THD%

Current THD% for each phase

### 3.2 Frequency and Power Factor and Demand

\*Not for SDM630-Standard V2

Each successive press of the button selects a new range:

Frequency and Power Factor (total).

Power Factor of each phase.

Maximum Current Demand.

Maximum Power Demand.

### 3.3 Power

\*Not for SDM630-Standard V2

Each successive press of the button select a new range:

Instantaneous Active Power in kW.

Instantaneous Reactive Power in KVAr.

Instantaneous Volt-Amps in KVA.

Total kW, kVAr, kVA.

### 3.4 Energy Measurements

Each successive press of the button selects a new range:

Total active energy in kWh.

Import active energy in kWh.

Export active energy in kWh.

Tariff 1~4 active energy  
\*For SDM630-MT V2 only  
Tariff 1~2 active energy  
\*For SDM630-2T V2 and SDM630Mbus-2T

Total reactive energy

Import reactive energy

Export reactive energy

Tariff 1~4 reactive energy  
\*For SDM630-MT V2 only  
Tariff 1~2 reactive energy  
\*For SDM630-2T V2 and SDM630Mbus-2T

Date  
Year/month/day.  
1st,Jan,2000 (default)  
\*For SDM630-MT V2 only

Time  
Hour/minute/second  
Example:00:02:16  
\*For SDM630-MT V2 only

\*The parameters of date and time can only be set via RS485 communication.

## 4.Set Up

To enter set-up mode, press the button for 3 seconds until the password screen appears.

Setting up is password-protected. The user must enter the correct password (default '1000') before processing.

If an incorrect password is entered, the display will show:

PASS Err

To exit setting-up mode, press repeatedly until the measurement screen is restored.

### 4.1 Set-up Entry Methods

Some menu items, such as password, require a four-digits number entry while others, such as supply system, require selection from a number of menu options.

#### 4.1.1 Menu Option Selection

- Use the and buttons to scroll through the different options of the set up menu.
- Press to confirm your selection
- If an item flashes, then it can be adjusted by the and buttons.
- Having selected an option from the current layer, press to confirm your selection.
- Having completed a parameter setting, press to return to a higher menu level, and you will be able to use the and buttons for further menu selection.
- On completion of all setting-up, press repeatedly until the measurement screen is restored.

#### 4.1.2 Number Entry Procedure

When setting up the unit, some screens require the entering of a number. In particular, on entry to the setting up section, a password must be entered. Digits are set individually, from left to right. The procedure is as follows:

- The current digit to be set flashes and is set using the and buttons
- Press to confirm each digit setting.
- After setting the last digit, press to exit the number setting routine.

## 4.2 Communication

### 4.2.1 RS485/Mbus Primary Address

\*Not for SDM630-Pulse V2

From the set-up menu, press and buttons to select the address ID.

(The range is from 001 to 247 for Modbus and 001 to 250 for Mbus)

Press button to enter the selection routine. The current setting will flash.

Use and buttons to choose Modbus or Mbus primary address

Press to confirm the setting and press to return to the main set up menu.

### 4.2.2 Mbus Secondary Address

\*For SDM630-Mbus V2 and SDM630Mbus-2T

Secondary address: 00 00 00 01 to 99 99 99 99  
From the set-up menu, use and buttons to find the setting page.

Press to enter the selection routine. The current setting will flash.

Use and buttons to set the secondary address

Press to confirm the setting and press to return to the main set up menu.

### 4.2.3 Baud Rate

Baud rate range for Modbus RTU: 2.4k, 4.8k, 9.6k, 19.2k, 38.4k. For Mbus: 0.3k, 0.6k, 2.4k, 4.8k, 9.6k.

From the set-up menu, use and buttons to select the baud rate option.

Press to enter the selection routine. The current setting will flash.

Use and buttons to choose baud rate.

Press to confirm the setting and press to return to the main set up menu.

### 4.2.4 Parity

From the set-up menu, use and buttons to select the parity option.

Press to enter the selection routine. The current setting will flash.

Use and buttons to choose parity (EVEN / ODD / NONE).

Press to confirm the setting and press to return to the main set up menu.

### 4.2.5 Stop Bits

From the set-up menu, use and buttons to select the stop bit option.

Press to enter the selection routine. The current setting will flash.

Use and buttons to choose stop bit (2 or 1)  
Note: Default is 1, and only when the parity is NONE that the stop bit can be changed to 2.

Press to confirm the setting and press to return to the main set up menu.

### 4.3 Pulse Output

This option allows you to configure the pulse output 1. The output can be set to provide a pulse for a defined amount of energy active or reactive. Use this section to set up the pulse output for:  
Total kWh/Total kVAh  
Import kWh/Export kWh  
Import kVAh/Export kVAh

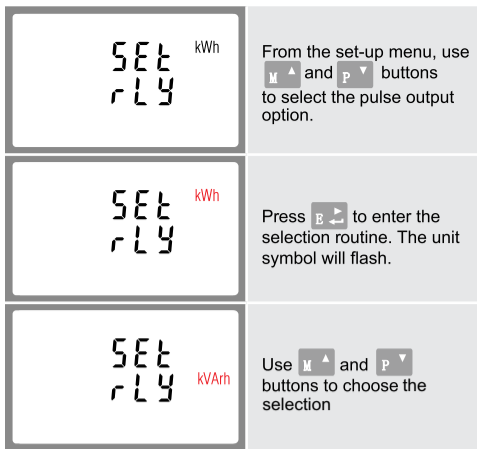

Press **Enter** to confirm the setting and press **U/I** to return to the main set up menu.

#### 4.3.1 Pulse Rate

Use this to set the energy represented by each pulse. Rate can be set to 1 pulse per dFt/0.01/0.1/1/10/100kWh/kVAh.



(It shows 1 pulse = 10kWh/kVAh)

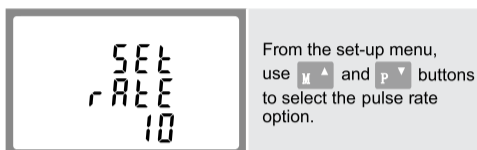

Use **M** and **P** buttons to choose pulse rate, then press **Enter** to confirm the setting and press **U/I** to return to the main set up menu.

#### 4.3.2 Pulse Duration

The pulse width can be selected as 200, 100 (default) or 60ms.



(It shows pulse width of 100ms)

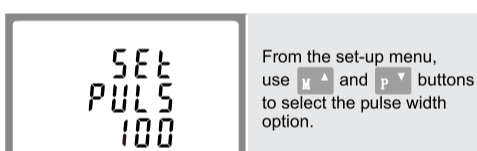

Use **M** and **P** buttons to choose pulse rate, then press **Enter** to confirm the setting and press **U/I** to return to the main set up menu.

#### 4.4 DIT Demand Integration Time

**\*Not for SDM630-Standard V2**

This sets the period in minutes over which the current and power readings are integrated for maximum demand measurement. The options are: 0, 5, 8, 10, 15, 20, 30, 60 minutes.

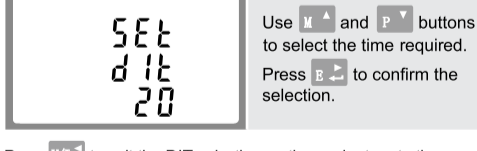
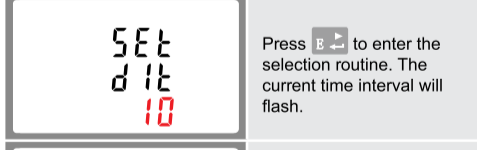
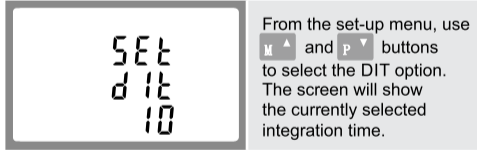

Press **U/I** to exit the DIT selection routine and return to the menu.

#### 4.5 Backlit Set-up

Backlit lasting time is settable, default lasting time is 60minutes

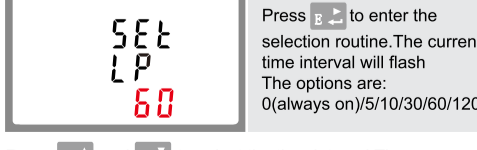
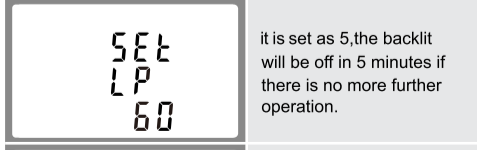

Press **M** and **P** to select the time interval. Then press **Enter** to confirm the set-up.

#### 4.6 Supply System

The unit has a default setting of 3 phase 4 wire (3P4W) Use this section to set the type of electrical system.

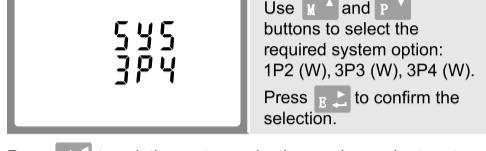
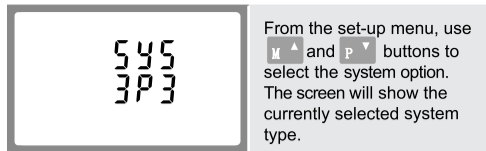

Press **U/I** to exit the system selection routine and return to the menu.

#### 4.7 CLR

**\*Not for SDM630-Standard V2**

The meter provides a function to reset the maximum demand value of current and power.

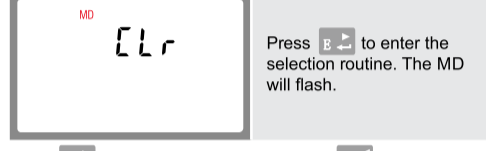
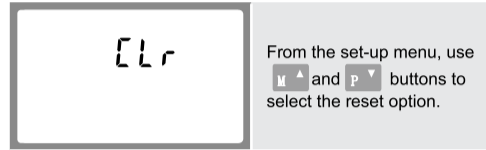

Press **Enter** to confirm the reset and press **U/I** to return to the main set up menu.

#### 4.8 Change Password

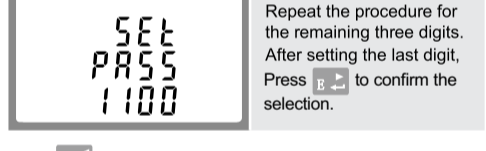
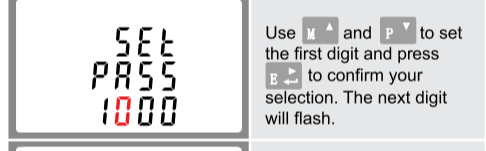
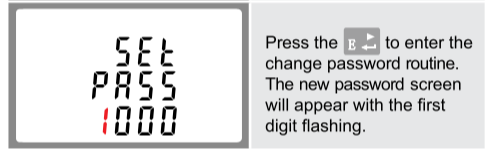
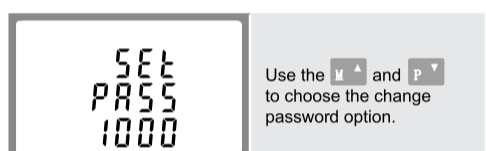

Press **U/I** to exit the number setting routine and return to the Set-up menu.

### 5. Specifications

#### 5.1 Measured Parameters

The unit can monitor and display the following parameters of a single phase two wire (1p2w), three phase three wire (3p3w) or three phase four wire (3p4w) system.

#### 5.1.1 Voltage and Current

**\*Not for SDM630-Standard V2**

- Phase to neutral voltages 176 to 276V a.c. (not for 3p3w supplies).
- Voltages between phases 304 to 480V a.c. (3p supplies only).
- Percentage total voltage harmonic distortion (THD%) for each phase to N (not for 3p3w supplies).
- Percentage voltage THD% between phases (three phase supplies only).
- Current THD% for each phase

#### 5.1.2 Power factor and Frequency and Max. Demand

**\*Not for SDM630-Standard V2**

- Frequency in Hz
- Power factor
- Instantaneous power:
- Power 0 to 99999 W
- Reactive power 0 to 99999 VA
- Volt-amps 0 to 99999 VA
- Maximum demanded power since last Demand reset
- Maximum neutral demand current, since the last Demand reset (for three phase supplies only)

#### 5.1.3 Energy Measurements

- Import active energy 0 to 999999.99 kWh
- Export reactive energy 0 to 999999.99 kVAh
- Import active energy 0 to 999999.99 kWh
- Export reactive energy 0 to 999999.99 kVAh
- Total active energy 0 to 999999.99 kWh
- Total reactive energy 0 to 999999.99 kVAh

#### 5.2 Measured Inputs

Voltage inputs through 4-way fixed connector with 25mm<sup>2</sup> stranded wire capacity, single phase two wire (1p2w), three phase three wire (3p3w) or three phase four wire (3p4w) unbalanced. Line frequency measured from L1 voltage or L3 voltage.

#### 5.3 Interfaces for External Monitoring

Three interfaces are provided:

- RS485/Mbus communication channel that via protocol remotely. (not for SDM630-Pulse V2)
- Pulse output (pulse1) indicating real-time measured energy. (configurable)
- Pulse output (pulse2) 400imp/kWh (non-configurable)

The Modbus/Mbus configuration (baud rate etc) and the pulse output assignments (kW/kVAh, import/export etc) are configured through the set-up screens

#### 5.4 Accuracy

- Voltage 0.5% of range maximum
- Current 0.5% of nominal
- Frequency 0.2% of mid-frequency
- Power factor 1% of unity (0.01)
- Active power (W) ±1% of range maximum
- Reactive power (VAr) ±1% of range maximum
- Apparent power (VA) ±1% of range maximum
- Active energy (Wh) Class 1 IEC 62053-21 Class B EN50470-1/3 Class 2 IEC 62053-23
- Reactive energy (VArh) 1s, typical, to >99% of final reading, at 50 Hz.
- Response time to step input

#### 5.5 Reference Conditions of Influence Quantities

Influence Quantities are variables that affect measurement errors to a minor degree. Accuracy is verified under nominal value (within the specified tolerance) of these conditions.

- Ambient temperature 23°C ± 2°C
- Input frequency 50 Hz (MID) 50 or 60Hz ±2% (non-MID) Sinusoidal (distortion factor < 0.005)
- Input waveform Sinusoidal (distortion factor < 0.005)
- Magnetic field of external origin Terrestrial flux

#### 5.6 Environment

- Operating temperature -25°C to +55°C\*
- Storage temperature -40°C to +70°C\*
- Relative humidity 0 to 95%, non-condensing
- Altitude Up to 2000m
- Warm up time 5s
- Vibration 10Hz to 50Hz, IEC 60068-2-6, 2g
- Shock 30g in 3 planes

\* Maximum operating and storage temperatures are in the context of typical daily and seasonal variation.

#### 5.7 Mechanics

- DIN rail dimensions 72 x 100 mm (WxH) per DIN 43880
- Mounting DIN rail (DIN35mm)
- Ingress protection IP51 (indoor)
- Material Self-extinguishing UL94 V-0

#### 5.8 Declaration of Conformity (for the MID approved version meter only)

We Zhejiang Eastron Electronic Co., Ltd. Declare under our sole responsibility as the manufacturer that the poly phase multifunction electrical meter "SDM630 100A series" correspond to the production model described in the EU-type examination certificate and to the requirements of the Directive 2014/32/EU EU type examination certificate number 0120/SGS0151. Identification number of the NB0120

### 6. Dimensions

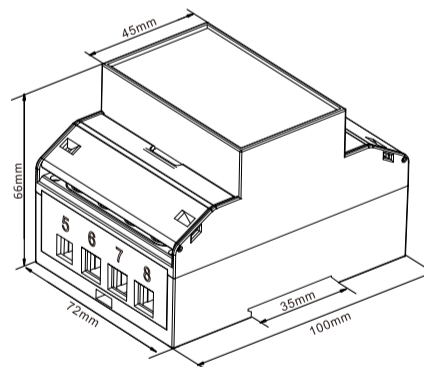

### 7. Wiring diagram

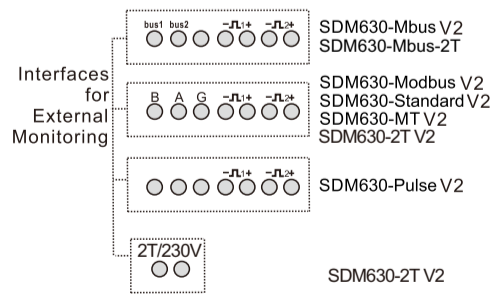

#### 7.1 single phase two wire

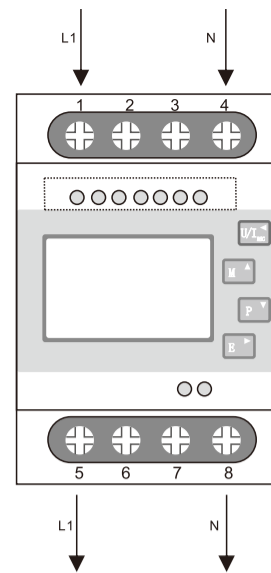

#### 7.2 three phase three wire

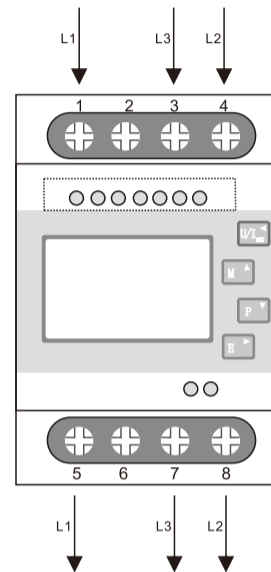

#### 7.3 three phase four wire

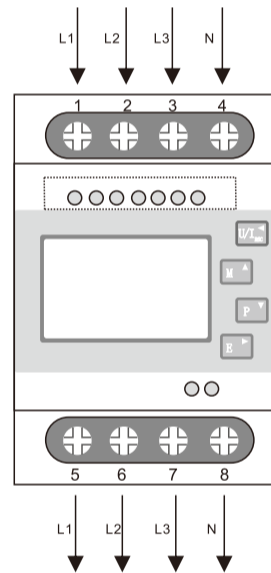

#### 7.4 Terminals Capacity and Screw Torque

Terminals Capacity	COMM / Pulse / 2T	0.5~1.5mm <sup>2</sup>
	Load	4~16mm <sup>2</sup>
Screw Torque	COMM / Pulse / 2T	0.4Nm
	Load	3Nm

Zhejiang Eastron Electronic Co., Ltd.  
No. 1369, Chengnan Rd.  
Jiaxing, Zhejiang, China  
Tel: 86 573 83698881/83698882  
Tel: 86 573 83698883  
Email: sales@eastron.com  
Web: www.eastrongroup.com



NO: 630000 V1.3